

PULLMAN ADVANCE E-TEK PRO MANUAL

Table of Contents

[On/off Button](#)

[Specifications](#)

[BEFORE YOU BEGIN](#)

[MAINTENANCE](#)

[Replacing filter](#)

[TROUBLESHOOTING](#)

[Problems and solution](#)

[SPARE PARTS](#)

[Conditions of warranty](#)

[Other ManualsLib Projects](#)



E-TEK PRO

700W MOTOR DRY VACUUM

Built-in USB port
Adjustable suction control
Cord rewriter with detachable power cord



**Made in
Germany**





PV800

Congratulations on the purchase of your new Pullman Advance E-Tek Pro. Your Pullman Advance E-Tek Pro has been manufactured to the highest quality and performance standards. We recommend that you read these instructions carefully to ensure peak cleaning performance and to extend the life of the vacuum.

Features:

1. Cord rewind handle
2. On/off button
3. 10m cord
4. Suction adjust button
5. Connection latches
6. Hose inlet
7. Wheels
8. On-board USB port
9. Extension rod

Accessories:

10. Crevice tool
11. Dusting brush
12. Combination floor tool
13. Hose
14. Dust bag
15. HEPA 13 fleece filter basket

Specifications:

Input Power: 700W
Dust Bag Capacity: 9L
Bin Capacity: 13L
Cord Length: 10m

Rod: 32mm Telescopic Rod
Hose: 2.5m
Net Weight: 8.8Kg
Gross Weight: 10.1Kg

1. BEFORE YOU BEGIN

Before you start using your new vacuum you should read this instruction booklet carefully and make sure that you have understood its contents. If not, please contact the store where you purchased your vacuum or call customer service 131 929.

Precautionary measures:

In the event that your vacuum should become blocked, please switch the vacuum off and remove the plug from the mains power point before you attempt to remove the blockage.



1. **Do not** operate the vacuum cleaner too close to heaters, radiators, cigarette butts etc.



2. Before you insert the plug into the mains power supply, make sure your hand is dry.



3. Before you start using the vacuum, please remove large or sharp objects from the floor in order to prevent the paper filter being damaged.



4. When you remove the plug from the mains power supply, please do this at the plug itself and not by the electrical cable.



5. **Do not** use vacuum to pick up water or liquids.

This vacuum is equipped with a cable restraint, cord and plug. In the event that either of these parts become damaged, it must be repaired by a qualified technician.

2. WARNING



IMPORTANT! Always switch off the wall outlet and cleaner, removing the plug from the electricity power supply before cleaning your appliance, when not in use or attempting any maintenance task. The vacuum must only be connected to an AC power supply at the voltage shown on the rating label. This vacuum should only be used for its intended purpose as described in this instruction manual. Never operate the vacuum without filters.

Safety precautions and warning:

When using your vacuum, basic precautions should always be observed, including the followings;

1. This appliance is not intended for use by persons (including children) with reduced physical, sensory or mental capabilities or lack of experience and knowledge, unless they have been given supervision or instruction concerning use of the appliance by a person responsible for their safety.
2. Children should be supervised to ensure that they do not play with the appliance.
3. To prevent electrical shock, do not immerse the top cover of the appliance, power cord or power plug into water or other liquids.
4. To prevent electric shock, do not use the vacuum cleaner outdoors.
5. Always check the power cord before use, the power cord and the plug should be in a good condition and must not be damaged. If the power supply cord is damaged or defective, it must be replaced by the manufacturer, its service agent or similarly qualified persons in order to avoid a hazard.
6. Do not unplug by pulling on the power cord. To unplug, grasp the plug not the power cord. Use only Australian and New Zealand electrical safety approved extension cords.
7. Do not pull or carry the appliance by the power cable, use the power cable as a handle or pull the power cable around sharp edges or corners. Avoid running the appliance over the power cable.
8. Ensure the appliance is switched off before unplugging.
9. Do not handle or operate the appliance with wet hands and follow electrical safety precautions at all times.
10. Extreme caution should be exercised when using the appliance on stairs.
11. Do not attempt to change the attachments while the appliance is plugged into Mains power supply. Switch off and remove plug from Mains power supply. Use only manufacturer's recommended accessories.
12. Do not operate the vacuum cleaner too close to heaters, radiators and other hot surfaces.
13. Do not use the appliance to pick up flammable items or combustible liquids (i.e. gasoline, hot

2. WARNING (CONTINUED)

- ashes cigarettes, matches, explosive materials or anything burning) or use in areas where such substances and items may be present.
14. Do not use the appliance to pick up toxic materials (i.e. chlorine bleach, ammonia).
 15. Ensure the appliance is disconnected from the Mains power supply before connecting the hose to the unit.
 16. Before vacuuming, remove any large or sharp objects from the floor or cleaning surface in order to prevent damage to the filter.
 17. If the air inlet, floor head or the telescopic tube is blocked, switch off the cleaner straight away and remove from the Mains power. First clear the blocked object before attempting to start the cleaner vacuum again.
 18. Do not leave the appliance unattended when it is connected to a Mains power supply.
 19. Before carrying out any maintenance service or cleaning the filters, always switch off the vacuum cleaner and disconnect the plug from power supply.
 20. Keep ends of the hose, telescopic tube and other openings away from your face and body.
 21. Do not use the vacuum cleaner if it is damaged or breaks down. Check the electrical regularly for defects. If connection cables, electrical hoses, electrical contacts and electrical tubes are damaged, have them replaced immediately.
 22. Never clean any of the electrical parts, especially the electrical connections with water or liquid cleaners.
 23. Never attempt to make any modifications electrically to the vacuum cleaner.
 24. Always store the appliance indoors in a cool and dry place.
 25. For indoor use only.
 26. Damage caused by improper use or by not observing the instructions in this manual will void warranty.

3. ASSEMBLY

Always switch off the wall outlet and cleaner before removing the plug from the electricity power supply before cleaning your appliance, assembling, when not in use or attempting any maintenance task.

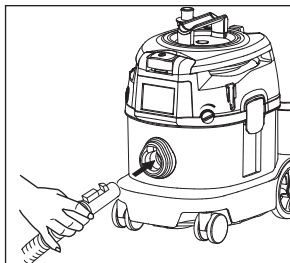

Connecting the hose

1. Insert the suction hose into the suction inlet on the vacuum unit until it clicks.
2. To remove the hose, press the hose release button and pull out the hose.

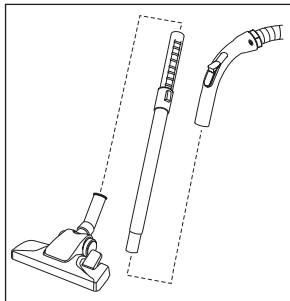

Fitting the rod and floor tool

1. Connect the hose handle to the rod.
2. Connect the rod to the desired cleaning accessory.

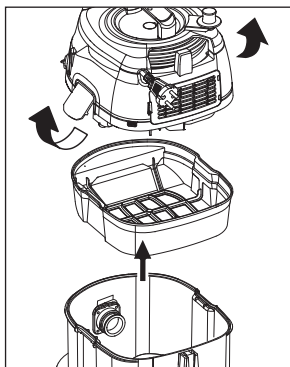

Filter check

1. Open the vacuum lid by releasing the side latches.
2. Ensure the filter basket is correctly seated inside the vacuum.
3. Make sure all filters (pre-filter, motor filter, etc.) are clean and properly installed.

3. ASSEMBLY (CONTINUED)

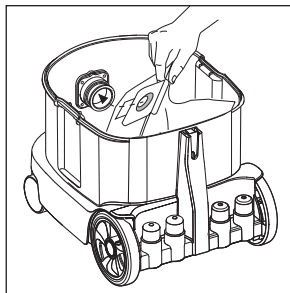

Dust bag check

1. Open the vacuum lid by releasing the side latches.
2. Ensure the dust bag is correctly seated inside the vacuum.
3. Close the lid and secure the latches.

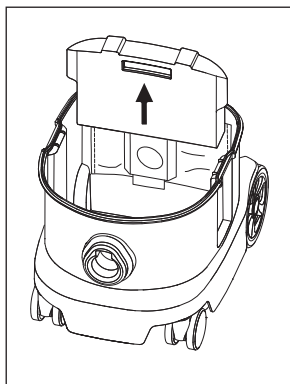

Note: A spare dust bag is stored inside the dust bin. Pull open the storage cover to access it.

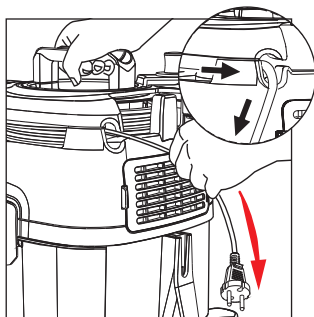

Release the power cord

1. Hold the vacuum lid handle firmly with one hand to stabilise the unit.
2. With the other hand, gently pull the power cord from the cord wrap around the lid.
3. Lock the power cord into the cord guide.

3. ACCESSORIES

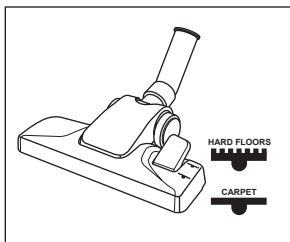

Combination floor tool

The combination floor tool is ideal for cleaning on carpets and hard floors.

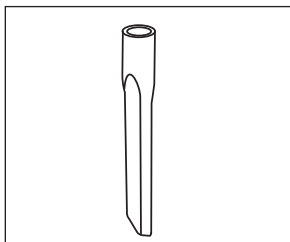

Crevice tool

Ideal for cleaning in tight spaces

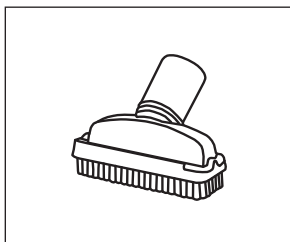

Dusting brush

Ideal for cleaning blinds, bookshelves and lampshades.

4. INSTRUCTIONS FOR USE

IMPORTANT! Do not use your vacuum if the power cord is damaged, or there are exposed internal wires. Do not use your vacuum if the motor housing is damaged.



Operating the vacuum

1. Connect the power cord to a power outlet.
2. Press the power button located on the vacuum to switch the unit ON

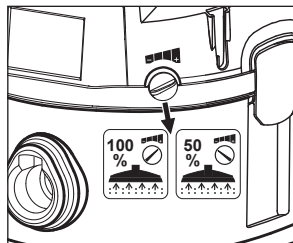

Variable suction

Ideal for cleaning blinds, bookshelves and lampshades.

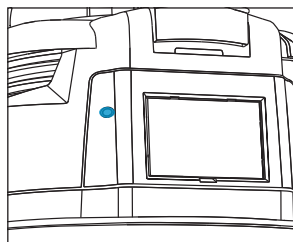

LED indicator

Blue: Indicates power is on.

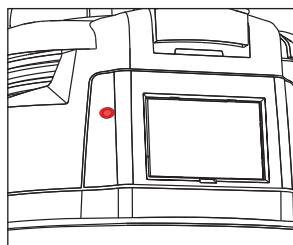

LED indicator

Red: Indicates clogging or full filter bag (from a motor power of 75%).

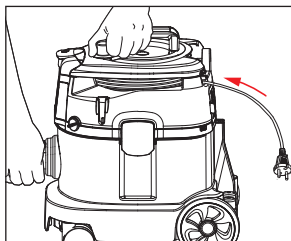

Rewinding the power cord

1. After cleaning, switch off the vacuum and unplug the power cord from the outlet.
2. Hold the vacuum hose inlet firmly to keep the unit stable.
3. Carefully wrap the power cord by turning the cord rewind handle on the lid. Ensure the cord is wound neatly without twists or kinks to avoid damage.

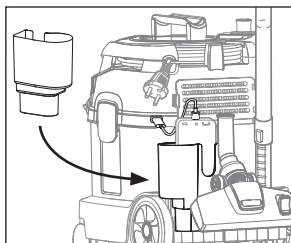

On-board USB port

Built-in USB port for convenient phone charging

5. MAINTENANCE

WARNING! Before any maintenance and cleaning - ensure your vacuum is turned off and the power cord is disconnected from the mains power supply.

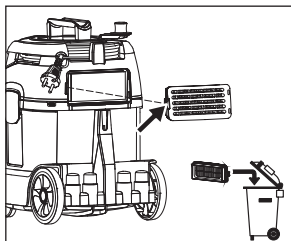

Replacing filter

1. Remove the filter and replace with a new one.

It is recommended to replace the filter every 3 months or when it becomes visibly dirty.

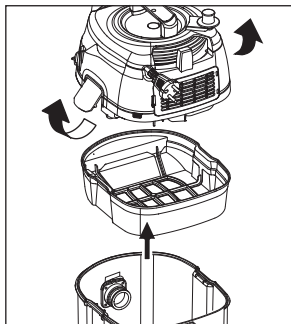

Cleaning filter basket

1. Open the vacuum lid by releasing the side latches.

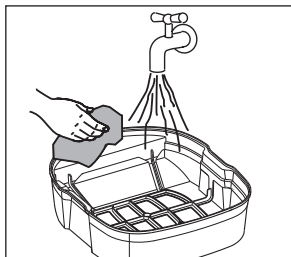

2. Thoroughly clean the filter basket to remove any dust and debris.
3. The filter basket can be rinsed with water if needed.
4. Ensure the filter basket is completely dry before placing it back into the machine.

It is recommended to replace the filter basket every 3 months or when it becomes visibly dirty.

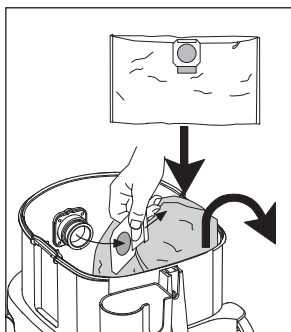

Replacing dust bag

1. Open the vacuum lid by releasing the side latches and remove the filter basket.
2. Disconnect the dust bag from the hose inlet. Gently slide the dust stopper into place to avoid dust leaking.

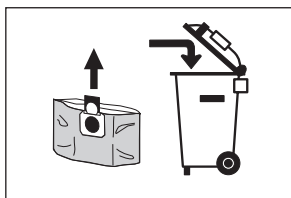

3. Dispose of the full dust bag in a waste bin.

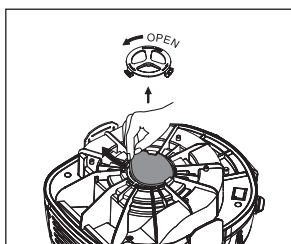

Replacing sponge filter

1. Open the dust bin lid to access the sponge filter underneath.
2. Turn the filter cap anti-clockwise to release it.

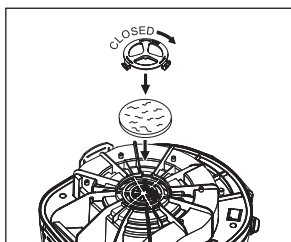

3. Replace with a new sponge filter in its place.
4. Reattach the filter cap and turn it clockwise to lock it into place.

It is recommended to replace the filter every 6 months or when it becomes visibly dirty.

5. MAINTENANCE (CONTINUED)



IMPORTANT! Always switch off the wall outlet and cleaner, removing the plug from the electricity power supply before making access to replace the power cord or attempting any maintenance task.

Changing power cord

1. Release the power cord from the cord guide.

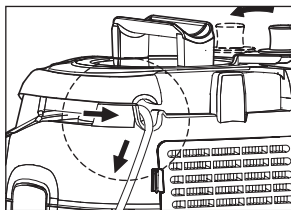

2. Gently unwind the power cord from around the lid.

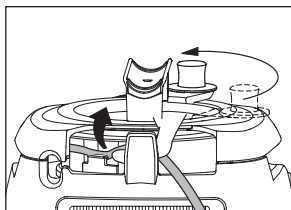

3. Continue pulling the power cord until the connector is visible.

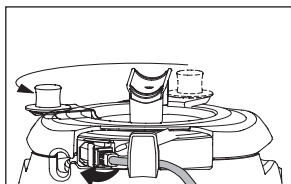

4. Gently disconnect the power cord from the socket.

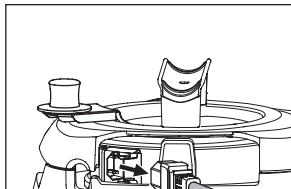

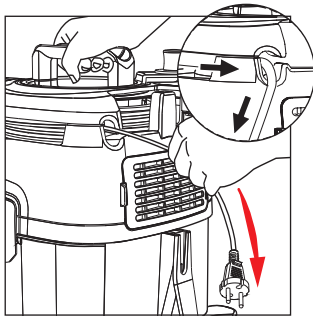

5. Re-insert new cord into the socket on the machine.
6. Lock the power cord into the cord guide.

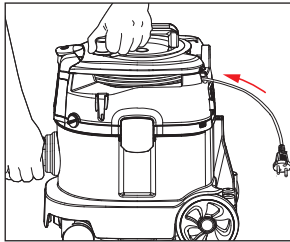

7. Gently re-wind the power cord into the cord rewinder.

6. TROUBLESHOOTING

Problems and solution

Please contact Pullman Advance Customer Support on 131 929 to find your local spare parts provider.

Fault	Treatment
The vacuum vacuum cleaner will not turn "On".	Check that the extension cord is inserted securely; remove the power plug and then reinsert into the mains power supply. Check that the On/Off switch is in the 'ON' position.
The vacuum vacuum performance is deteriorating.	Check the vacuum to ensure there are no blockages. Please clear any blockages that may be found. (Important: always first remove the plug from the mains power point). Check the cloth filter bag (inlet and exhaust) to see if it needs to be cleaned or replaced.
The cleaner makes an abnormal sound when switched on.	Check the vacuum to ensure there are no blockages. Please clear any blockages that may be found. (Important: always first remove the plug from the mains power point).
The vacuum vacuum has no suction, it turns off after a few minutes and not able to turn back on.	Check for a blockage in the hose, rod or floor tool that may be restricting air flow. If found, remove the blockage and allow approximately 30-60 minutes for the motor to cool down before operating the machine again. (Important: always first remove the plug from the mains power point).

7. SPARE PARTS

Part Number	Part Description
31221091	Hose Pullman Advance E-Tek Pro Li-Tek Pro
33158670	Tank assy with wheels Pullman Advance
32440609	Paper bags HEPA13 10pk Pullman Advance
32201964	Motor inlet filter Pullman Advance
32201965	Exhaust filter HEPA13 Pullman Advance
32201966	Canister filter with frame
33202457	Power cord Pullman Advance E-Tek Pro PV800
33158671	Cord retractor Pullman Advance E-Tek Pro
33301085	Motor 700w Pullman Advance E-Tek Pro PV800
33158672	Tank clip set Pullman Advance E-Tek Pro
31155833	Combo floor tool Pullman Advance E-Tek Pro
31300885	Tele rod 32mm Pullman Advance E-Tek Pro

Conditions of warranty



Your Pullman Advance E-Tek Pro, in the case of domestic use, has a two years warranty against product defects and failures when the product is used in accordance with the terms and conditions of this warranty statement.

This warranty is provided by Future Innovation Holdings Pty Ltd Trading as Godfreys Commercial ABN 98 677 632 021. This warranty commences from the original date of purchase and is not transferable. You are required to retain your original proof of purchase for any claims under this warranty. This warranty is valid only in the country where the cleaner is purchased.

Your Pullman Advance E-Tek Pro must be operated in accordance with these instructions and used only for domestic household cleaning to remove dry dirt and dust from household carpets, flooring and fabrics. Your Pullman Advance E-Tek Pro is not fit to be used as an industrial cleaner, and is not designed for the collection of vitreous building material including particle board, construction products and similar products such as wood/ fibres, cement, fillers, fibre glass etc or excessive or frequent sand. The infrequent pick-up of these materials may be harmful to your cleaner and will void this warranty.

Accessories and consumables including dust bags and filters, unless defective in manufacture, are not subject to this warranty. In order to prolong the life of accessories and consumables, regular care and maintenance is recommended.

Refer to the instruction manual for further regarding the use and care of your Pullman Advance E-Tek Pro, as misuse or failure to follow the instructions voids this warranty.

In the event of service or advice being needed, or if you would like to make a claim under this warranty, please immediately stop using the Pullman Advance E-Tek Pro and contact Godfreys Commercial, 2 Drake Boulevard Altona, VIC 3018, or on 131 929, Monday-Friday 9am-5pm AEST or commercialsupport@godfreys.com.au.

The decision to repair or replace the cleaner is at the discretion of Godfreys Commercial depending on the circumstances and

requirements of any applicable law. If Godfreys Commercial decide to repair or replace your Pullman Advance E-Tek Pro, it will do so at its own cost. Any transportation costs involved in a claim under this warranty shall be borne by the claimant.

Godfreys Commercial is unable to accept responsibility under this warranty for any repair work not carried out by an authorised Service Agent, or any defect arising from or in connection with the use of non-genuine parts. If any part is no longer available or manufactured, Godfreys Commercial will replace it with a genuine functional replacement part. This warranty does not apply to the cost of replacing any parts of the Pullman Advance E-Tek Pro due to normal wear and tear, alterations, improper installation, physical abuse, misuse or accidental damage.

If proof of purchase cannot be provided at the time of a warranty claim or service, any work carried out on the Pullman Advance E-Tek Pro will be at claimant's cost.

The repair of the Pullman Advance E-Tek Pro under this warranty does not extend the original period of warranty. If your Pullman Advance E-Tek Pro is replaced under this warranty, the replacement will be covered by this warranty for the remainder of the original warranty period. However, you may still have statutory rights after this time.

The benefits conferred by this warranty are in addition to all other rights and remedies in respect of the product as outlined under the Competition and Consumer Act 2010 (Cth) and other State and Territory laws.

Our goods come with guarantees that cannot be excluded under the Australian Consumer Law. You are entitled to a replacement or refund for a major failure and compensation for any other reasonably foreseeable loss or damage. You are also entitled to have the goods repaired or replaced if the goods fail to be of acceptable quality and the failure does not amount to a major failure.



Other ManualsLib Projects



www.manualslib.com



www.manualslib.de



www.manualslib.es



www.manualslib.fr



www.manualslib.nl



www.manualslib.mx



www.manualslib.tech 30+ Languages